

# Pin Header 2.0mm 1 & 2 & 3 & 4 Row H=1.5/2.0mm Straight Type

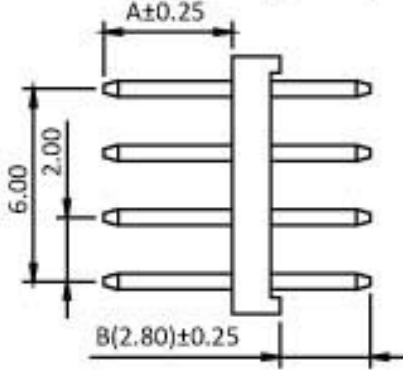

⊙ : Standard Dimensions

	Dimensions	
	A	B
H=1.50mm	3.90	2.80
H=2.00mm	3.90	2.80

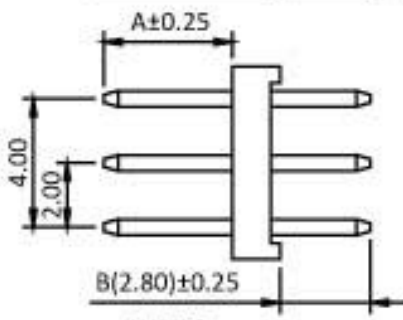
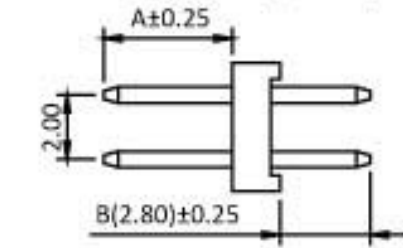
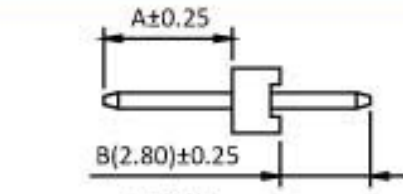
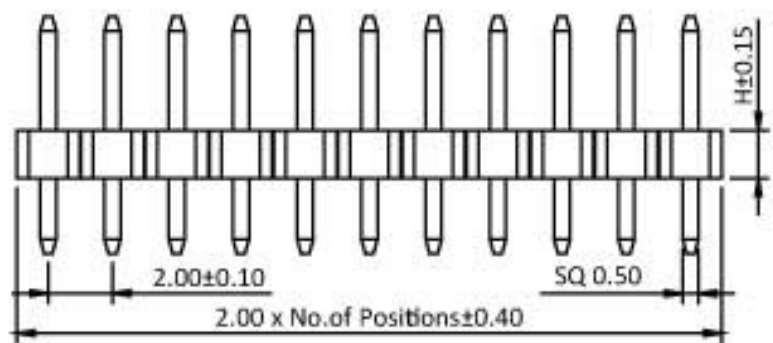
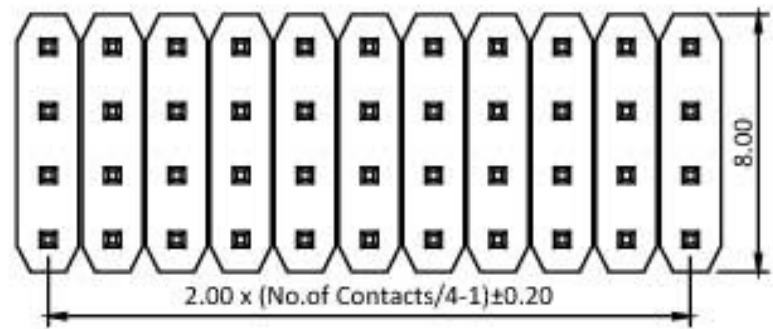
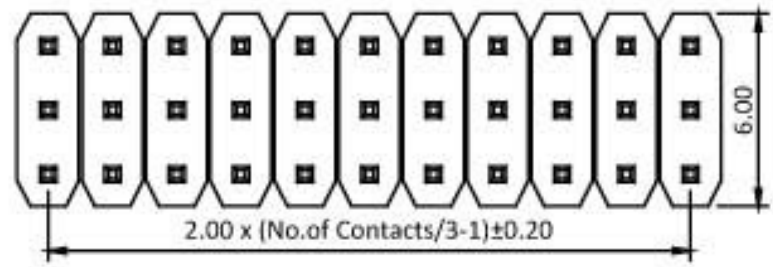
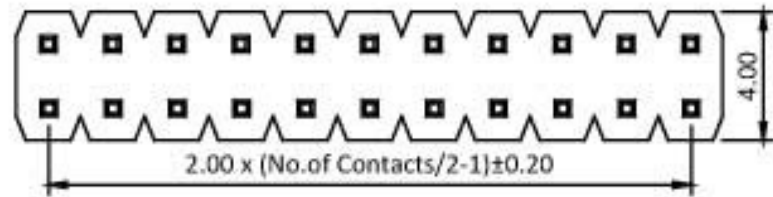
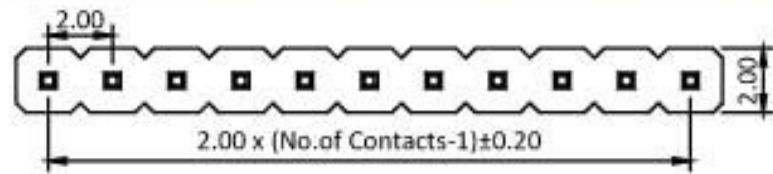
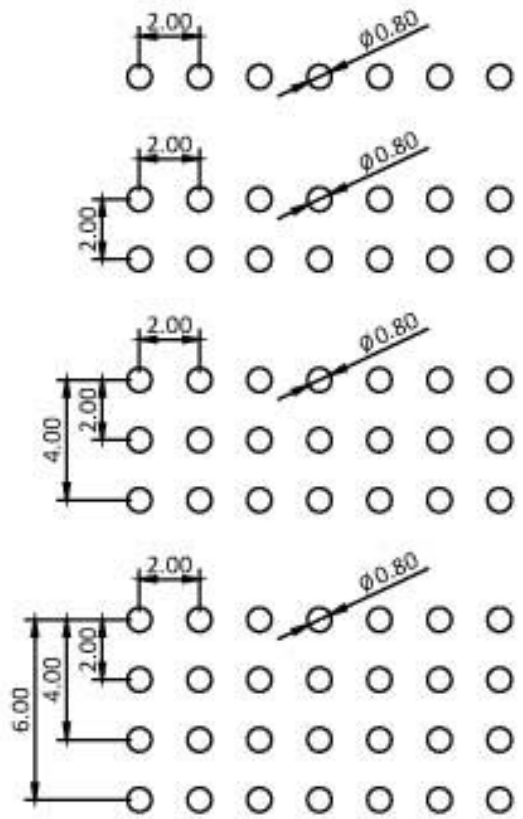

Recommended PCB Layout  
(PCB TOLERANCE ±0.05)

