

Pin Header 2.54mm 1 & 2 Row H=2.5mm Press Fit Type

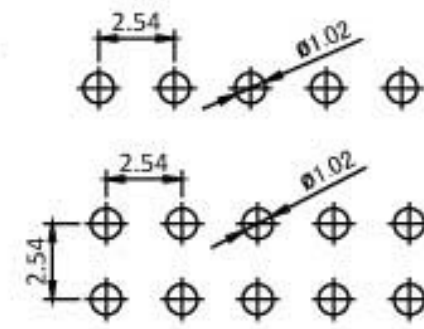
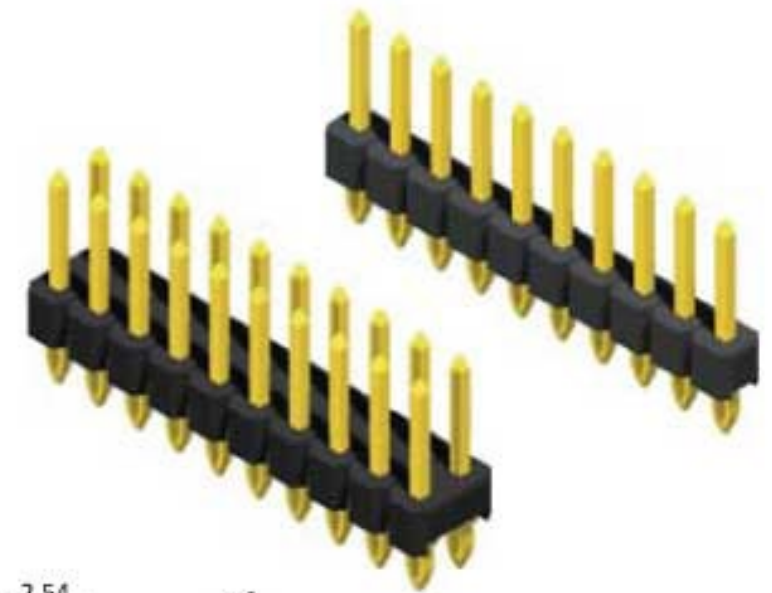
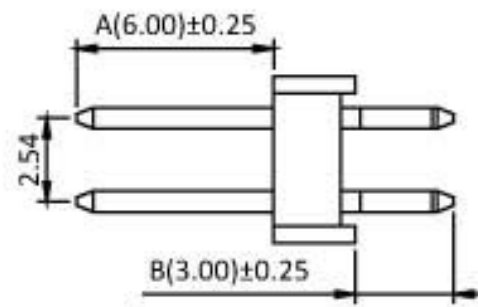
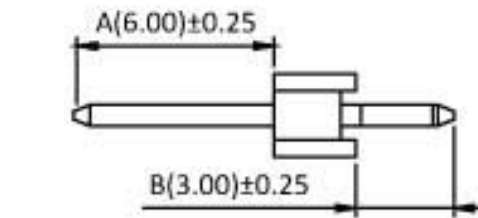
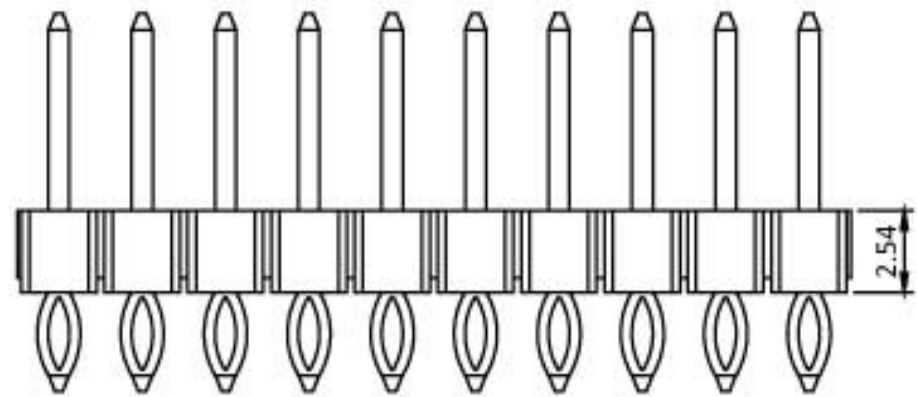
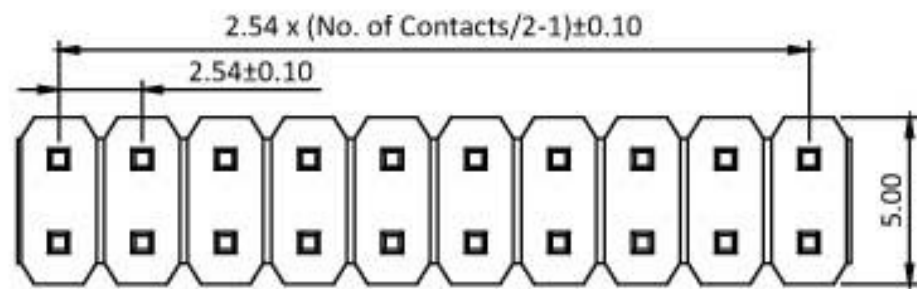
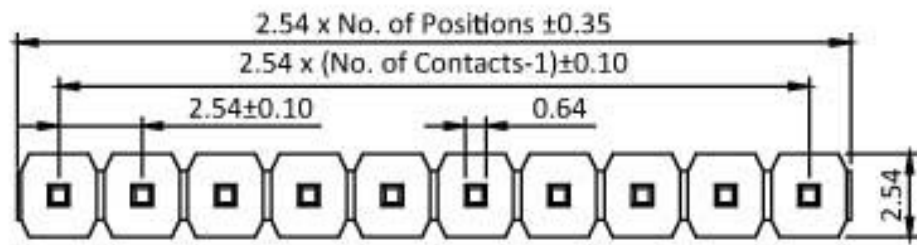

Recommended PCB Layout
(PCB TOLERANCE ± 0.05)